



# ENTRANCE & WINDOW SYSTEMS



**Blackstock Lumber Co., Inc.**  
1039 Elliott Avenue West • Seattle, WA 98119  
Phone (206) 284-1313 • Fax (206) 281-0062  
[www.blackstocklumber.com](http://www.blackstocklumber.com)



# ENTRANCE & WINDOW SYSTEMS

**NOTICE :**

**PL PREMIUM ADHESIVE MUST BE USED ON ALL JOINTS.**

## CUSTOM SIZE HEADERS



**CSH 1004** (See MD 1004 on page 79)  
• 3 1/2" Projection • 12 3/4" Height



**CSH 1006** (See MD 1006 on page 75)  
• 5" Projection • 14" Height



**CSH 1015** (See MD 1015 on page 75)  
• 4 1/4" Projection • 9 3/8" Height

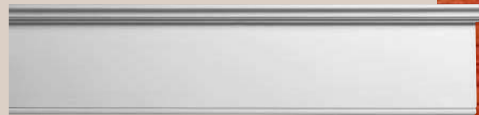

**CSH 1018** (See MD 1018 on page 85)  
• 1 1/2" Projection • 9" Height



**CSH 1025** (See MD 1025 on page 79)  
• 1 1/2" Projection • 5 1/2" Height



**CSH 1035** (See MD 1035 on page 74)  
• 3" Projection • 9" Height



**CSH 1038** (See MD 1038 on page 65)  
• 5 3/4" Projection • 8 5/8" Height



**CSH 1052** (See MD 1052 on page 74)  
• 3 3/4" Projection • 6" Height



**CSH 1142** (See MD 1142 on page 75)  
• 6" Projection • 7" Height

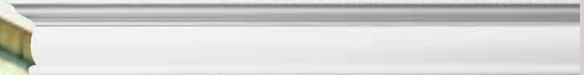

**CSH 1158** (See MD 1158 on page 74)  
• 3" Projection • 5" Height

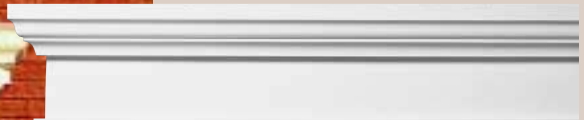

**CSH 1252** (See MD 1252 on page 75)  
• 4" Projection • 10" Height



**CSH 1267** (See MD 1267 on page 74)  
• 2 7/8" Projection • 6" Height



**CSH 1316** (See MD 1316 on page 65)  
• 4 1/4" Projection • 9 3/8" Height



**CSH 1335** (See MD 1335 on page 75)  
• 4" Projection • 9 1/4" Height

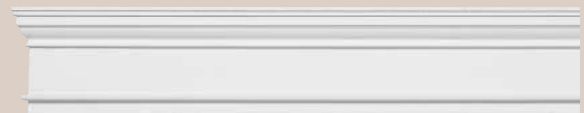

**CSH 1336** (See MD 1336 on page 75)  
• 4" Projection • 9 1/4" Height



*SEE SIZE CHART IN  
PRICE LIST ALL  
HEADERS COME  
WITH RETURNED  
ENDS.*

Keystones available  
on page 40

1 • 8 0 0 • 6 8 5 • 9 9 8 1



# ENTRANCE & WINDOW SYSTEMS



## PEDIMENTS

<b>ACORN PEDIMENT</b>		<b>SUNBURST PEDIMENT</b>		<b>PEAKED PEDIMENT</b>		<b>RAMS HEAD PEDIMENT</b>	
AP 5315	AP 8421	SP 5315	SP 8423	PP 5314	PP 8421	RH 5319	RH 8424
AP 5716	AP 9023	SP 5716	SP 9021	PP 5715	PP 9023	RH 5718	RH 9024
AP 7018	AP 9823	SP 7018	SP 9825	PP 7018	PP 9825	RH 7022	RH 9826

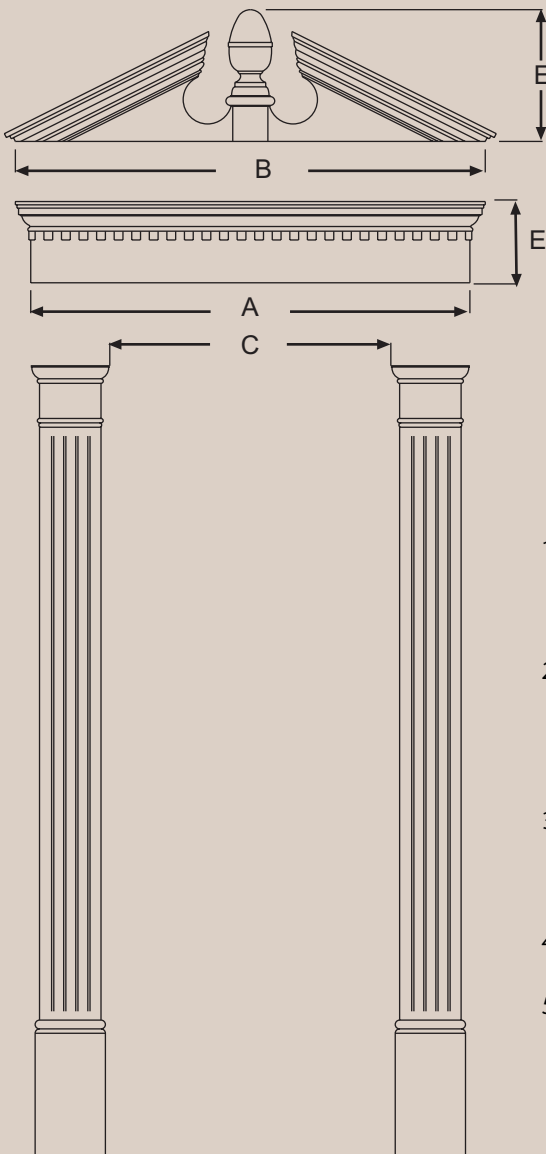

## CROSSHEADS

<b>CROSSHEAD WITH TRIM STRIP</b>		<b>CROSSHEAD WITH TRIM STRIP EXTENDED</b>	
CHT 5009	CHT 8109	CHT 5011	CHT 8111
CHT 5409	CHT 8309	CHT 5411	CHT 8311
CHT 6609	CHT 8609	CHT 6611	CHT 8611
CHT 7809	CHT 9409	CHT 7811	CHT 9411

## ENTRANCE SYSTEM INSTRUCTIONS

1. Measure door opening. If the brickmould is to remain on the door frame be sure to take this into account. This will give you the "C" dimension. (Example: 36")
2. On the Entrance system Chart under pilasters locate the "C" dimension size to determine which pilasters to use. (Example 36" you would use 7" pilasters to give you an "A" measurement of 50")
3. Move across the chart to choose the Header you want. Choose the pediment which is directly below. (Example: CHT 5009 & AP 5315)
4. On the pilaster page pick out the style you desire.
5. If your door has sidelights pick out the style of Mull Strip you desire. Note these Mull Strips go between the door and the sidelights.

<b>CROSSHEAD WITH DENTIL</b>	
CHD 5009	CHD 8109
CHD 5409	CHD 8309
CHD 6609	CHD 8609
CHD 7809	CHD 9409

MULL STRIPS			
PRODUCT NUMBER	WIDTH	HEIGHT	PROJECTION
MS 284-F	2"	84"	1 1/8"
MS 284-P	2"	84"	1 1/8"





# ENTRANCE & WINDOW SYSTEMS

NOTICE :

PL PREMIUM ADHESIVE MUST BE USED ON ALL JOINTS.

ENTRANCE SYSTEM CHART										
PILASTERS					DESCRIPTION	PRODUCT NUMBER	"A" WIDTH	"B" WIDTH	PROJECTION	"E" HEIGHT
5"	6"	7"	8"	9"						
"C" DIMENSIONS										
40"	38"	36"	34"	32"	Crosshead w/Trim Strip	CHT 5009	50"		4"	9 1/4"
					Crosshead w/Trim Strip Extended	CHT 5011	50"		4"	11"
					Crosshead w/Dentil	CHD 5009	50"		4"	9 1/4"
					Acorn Pediment	AP 5315		53 1/2"	4"	15"
					Sunburst Pediment	SP 5315		53 1/2"	4"	15 7/8"
					Peaked Pediment	PP 5314		53 1/2"	4"	14 1/2"
					Rams Head Pediment	RH 5319		53 1/2"	6"	19 1/2"
44"	42"	40"	38"	36"	Crosshead w/Trim Strip	CHT 5409	54"		4"	9 1/4"
					Crosshead w/Trim Strip Extended	CHT 5411	54"		4"	11"
					Crosshead w/Dentil	CHD 5409	54"		4"	9 1/4"
					Acorn Pediment	AP 5716		57"	4 1/2"	16"
					Sunburst Pediment	SP 5716		57"	5"	16"
					Peaked Pediment	PP 5715		57"	4 1/2"	15 1/4"
					Rams Head Pediment	RH 5718		57"	6"	18 1/2"
56"	54"	52"	50"	48"	Crosshead w/Trim Strip	CHT 6609	66"		4"	9 1/4"
					Crosshead w/Trim Strip Extended	CHT 6611	66"		4"	11"
					Crosshead w/Dentil	CHD 6609	66"		4"	9 1/4"
					Acorn Pediment	AP 7018		70 1/4"	4"	18"
					Sunburst Pediment	SP 7018		70 1/4"	6"	18 1/4"
					Peaked Pediment	PP 7018		70 1/4"	4"	18 1/4"
					Rams Head Pediment	RH 7022		70 1/4"	5 1/8"	22 3/8"
68 3/4"	66 3/4"	64 3/4"	62 3/4"	60 3/4"	Crosshead w/Trim Strip	CHT 7809	78 3/4"		4"	9 1/4"
					Crosshead w/Trim Strip Extended	CHT 7811	78 3/4"		4"	11"
					Crosshead w/Dentil	CHD 7809	78 3/4"		4"	9 1/4"
71"	69"	67"	65"	63"	Crosshead w/Trim Strip	CHT 8109	81"		4"	9 1/4"
					Crosshead w/Trim Strip Extended	CHT 8111	81"		4"	11"
					Crosshead w/Dentil	CHD 8109	81"		4"	9 1/4"
					Acorn Pediment	AP 8421		84 1/2"	4"	21 1/2"
					Sunburst Pediment	SP 8423		84 1/2"	6"	23 3/4"
					Peaked Pediment	PP 8421		84 1/2"	4"	21 1/4"
					Rams Head Pediment	RH 8424		84 1/2"	6"	24"
73"	71"	69"	67"	65"	Crosshead w/Trim Strip	CHT 8309	83"		4"	9 1/4"
					Crosshead w/Trim Strip Extended	CHT 8311	83"		4"	11"
					Crosshead w/Dentil	CHD 8309	83"		4"	9 1/4"
76 3/4"	74 3/4"	72 3/4"	70 3/4"	68 3/4"	Crosshead w/Trim Strip	CHT 8609	86 3/4"		4"	9 1/4"
					Crosshead w/Trim Strip Extended	CHT 8611	86 3/4"		4"	11"
					Crosshead w/Dentil	CHD 8609	86 3/4"		4"	9 1/4"
					Acorn Pediment	AP 9023		90"	4 1/2"	23 1/8"
					Sunburst Pediment	SP 9021		90"	6"	21 1/8"
					Peaked Pediment	PP 9023		90"	4 1/2"	23"
					Rams Head Pediment	RH 9024		90"	6"	24 3/4"
84 3/4"	82 3/4"	80 3/4"	78 3/4"	76 3/4"	Crosshead w/Trim Strip	CHT 9409	94 3/4"		4"	9 1/4"
					Crosshead w/Trim Strip Extended	CHT 9411	94 3/4"		4"	11"
					Crosshead w/Dentil	CHD 9409	94 3/4"		4"	9 1/4"
					Acorn Pediment	AP 9823		98"	4"	23 7/16"
					Sunburst Pediment	SP 9825		98"	7"	25 1/4"
					Peaked Pediment	PP 9825		98"	4"	25 1/2"
					Rams Head Pediment	RH 9826		98"	7"	26 3/4"

1 • 800 • 685 • 9981



# ENTRANCE & WINDOW SYSTEMS



## 1 FLUTED PILASTER

- PL 452 F • 2 1/4" p. x 51 3/4" h. x 4 9/16" w.
- PL 590 F • 2 1/4" p. x 90" h. x 5" w.
- PL 690 F • 2 1/4" p. x 90" h. x 6" w.
- PL 769 F • 2 1/4" p. x 69" h. x 7" w.
- PL 790 F • 2 1/4" p. x 90" h. x 7" w.
- PL 890 F • 2 1/4" p. x 90" h. x 8" w.
- PL 960 F • 2 1/4" p. x 60" h. x 9" w.
- PL 990 F • 2 1/4" p. x 90" h. x 9" w.
- PL 999 F • 2 1/4" p. x 99" h. x 9" w.
- PL 6108 F • 2 1/4" p. x 108" h. x 6" w.
- PL 7102 F • 2 1/4" p. x 102" h. x 7" w.
- PL 11108 F • 2 1/4" p. x 108" h. x 11" w.

## 2 DOUBLE PANEL PILASTER

- PL 590 DP • 2 1/4" p. x 90" h. x 5" w.
- PL 690 DP • 2 1/4" p. x 90" h. x 6" w.
- PL 790 DP • 2 1/4" p. x 90" h. x 7" w.
- PL 890 DP • 2 1/4" p. x 90" h. x 8" w.
- PL 990 DP • 2 1/4" p. x 90" h. x 9" w.
- PL 9102 DP • 2 1/4" p. x 102" h. x 9" w.

## 3 SINGLE PANEL PILASTER

- PL 590 P • 2 1/4" p. x 90" h. x 5" w.
- PL 690 P • 2 1/4" p. x 90" h. x 6" w.
- PL 790 P • 2 1/4" p. x 90" h. x 7" w.
- PL 890 P • 2 1/4" p. x 90" h. x 8" w.
- PL 990 P • 2 1/4" p. x 90" h. x 9" w.
- PL 1190 P • 2 1/4" p. x 90" h. x 11" w.
- PL 9102 P • 2 1/4" p. x 102" h. x 9" w.



## PILASTERS

## 4 SMOOTH PILASTER

- PL 793 SM • 2 1/4" p. x 93" h. x 7" w.

## 5 LONG FLUTED PILASTER

- PL 490 LF • 1 7/8" p. x 90" h. x 4" w.
- PL 690 LF • 1 7/8" p. x 90" h. x 6" w.

## 6 PILASTER

- PL 1144L
- PL 1144R
- 1 3/4" p. x 96" h.
- Matches MD 1144

## 7 PILASTER

- PL 5108 • 1 5/8" p. x 118 9/16" h. x 5 1/4" w.
- Plinth Block is a separate piece

## 8 PANEL MULL

- PL 284 P • 1 1/8" p. x 84" h. x 2" w.

## 9 FLUTED MULL

- PL 284 F • 1 1/8" p. x 84" h. x 2" w.

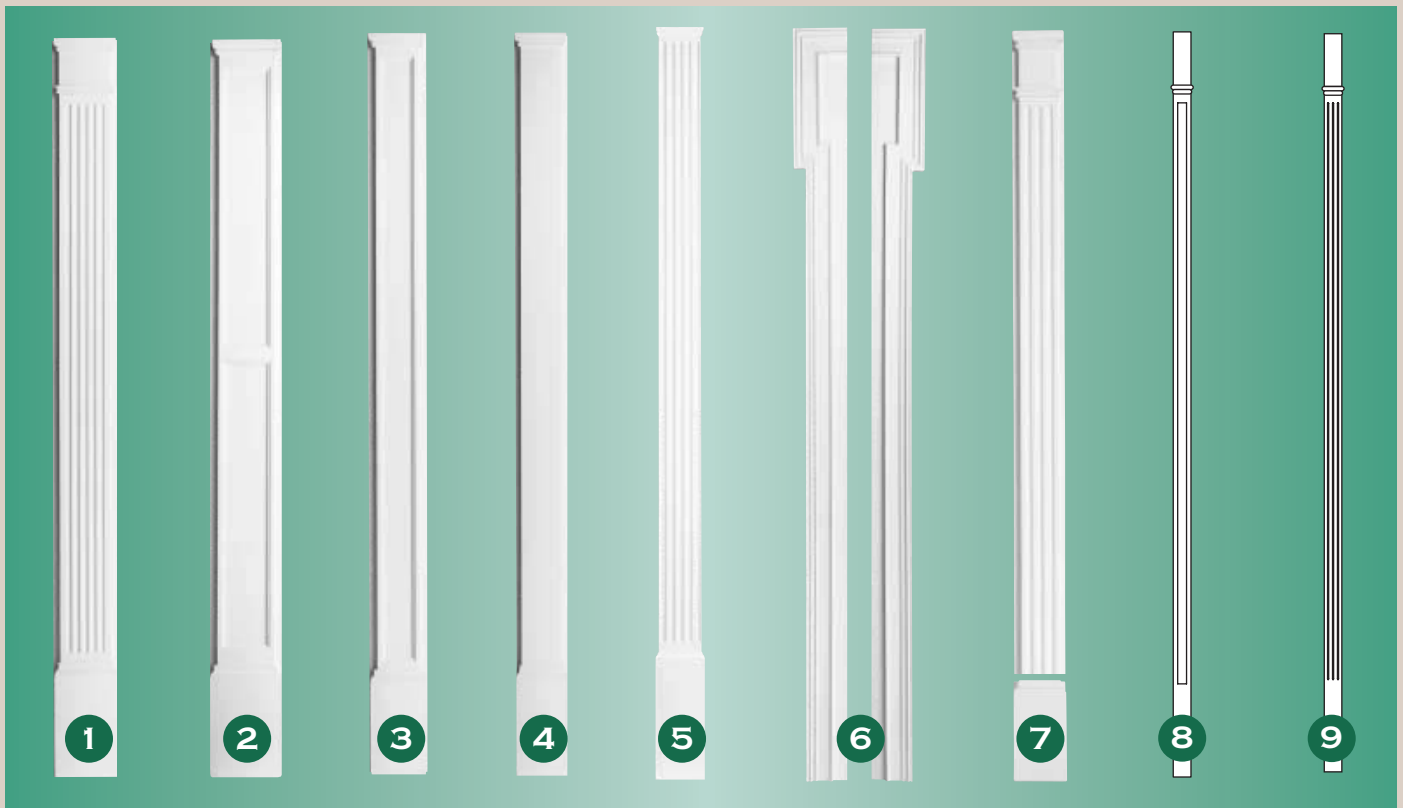



# ENTRANCE & WINDOW SYSTEMS

NOTICE :

PL PREMIUM ADHESIVE MUST BE USED ON ALL JOINTS.



• 1 3/4" Projection

- HCS 2815** • 28" Width • 15" Height
- HCS 3217** • 32" Width • 17" Height
- HCS 3318** • 33" Width • 18" Height
- HCS 3619** • 36" Width • 19" Height
- HCS 3720** • 37" Width • 20" Height
- HCS 4021** • 40" Width • 21" Height
- HCS 4423** • 44" Width • 23" Height
- HCS 4825** • 48" Width • 25" Height
- HCS 5227** • 52" Width • 27" Height
- HCS 5629** • 56" Width • 29" Height
- HCS 6031** • 60" Width • 31" Height
- HCS 7237** • 72" Width • 37" Height
- HCS 7639** • 76" Width • 39" Height
- HCS 9649** • 96" Width • 49" Height

• 1 3/4" Projection

- HSS 3209** • 32" Width • 9" Height
- HSS 3309** • 33" Width • 8 1/4" Height
- HSS 3609** • 36" Width • 9" Height
- HSS 3612** • 36" Width • 12" Height
- HSS 3709** • 37" Width • 9" Height
- HSS 4010** • 40" Width • 10" Height
- HSS 4812** • 48" Width • 12" Height
- HSS 5212** • 52" Width • 12" Height
- HSS 6013** • 60" Width • 13" Height
- HSS 7214** • 72" Width • 14" Height
- HSS 7615** • 76" Width • 15" Height
- HSS 9617** • 96" Width • 17" Height
- HSS 14414** • 144" Width • 14 1/2" Height

## SUNBURSTS

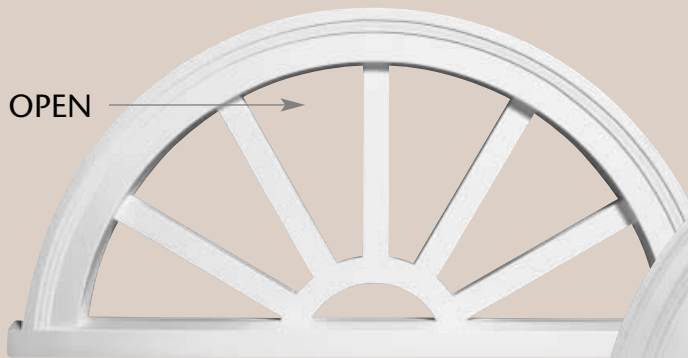

OPEN →



• 1 3/8" Projection

- SHR 2613** • 26" Width • 13" Height
- SHR 3819** • 38" Width • 19" Height
- SHR 5025** • 50" Width • 25" Height
- SHR 6030** • 60" Width • 30" Height

• 1 3/8" Projection

- SHC 4224** • 42" Width • 24" Height
- SHC 4824** • 48" Width • 24" Height
- SHC 5025** • 50" Width • 25" Height
- SHC 5828** • 58" Width • 28" Height

1 • 800 • 685 • 9981



# ENTRANCE & WINDOW SYSTEMS

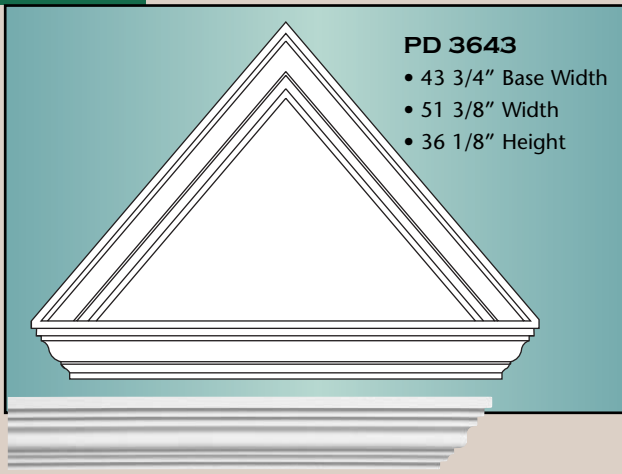

- PD 3643**
- 43 3/4" Base Width
  - 51 3/8" Width
  - 36 1/8" Height

- MD 1207**
- This moulding can be used to make returns on PD 3643



- PWH 4421**
- 44" Base Width
  - 21 3/4" Height

## PEDIMENTS



- WH 33**
- 3 1/4" Projection
  - 46 7/8" Width
  - 10 3/8" Height



- PD 25102**
- 3 1/8" Projection
  - 98 1/2" Base Width
  - 101 3/8" Top Width
  - 25 1/2" Height

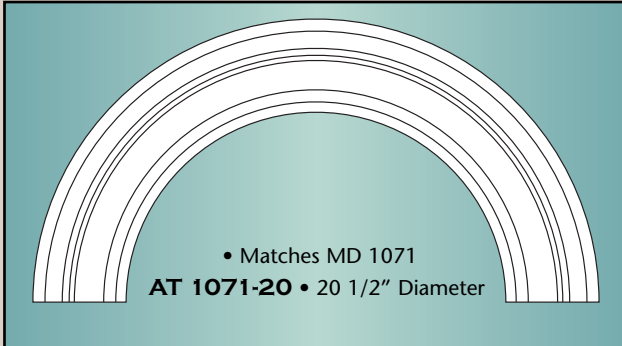

- Matches MD 1071  
**AT 1071-20** • 20 1/2" Diameter

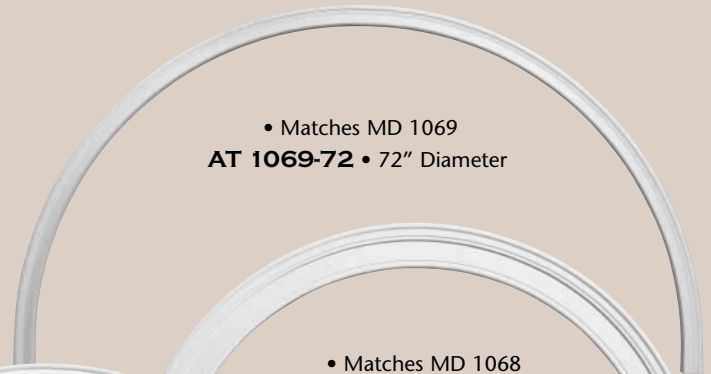

- Matches MD 1069  
**AT 1069-72** • 72" Diameter

## ARCHES

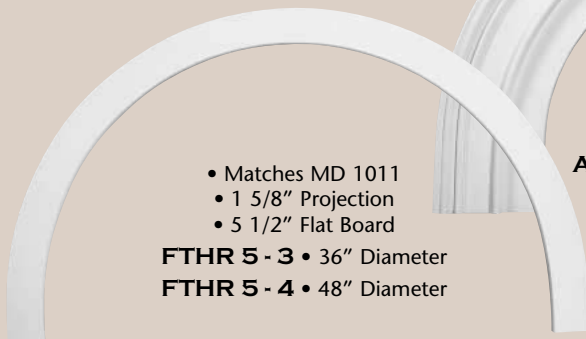

- Matches MD 1011  
 • 1 5/8" Projection  
 • 5 1/2" Flat Board  
**FTHR 5 - 3** • 36" Diameter  
**FTHR 5 - 4** • 48" Diameter

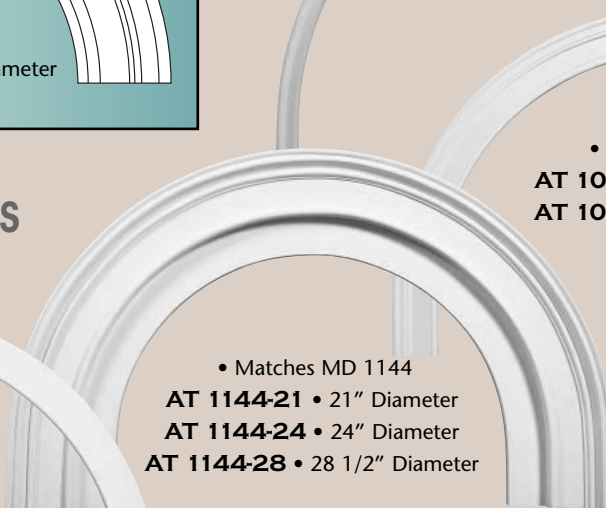

- Matches MD 1144  
**AT 1144-21** • 21" Diameter  
**AT 1144-24** • 24" Diameter  
**AT 1144-28** • 28 1/2" Diameter

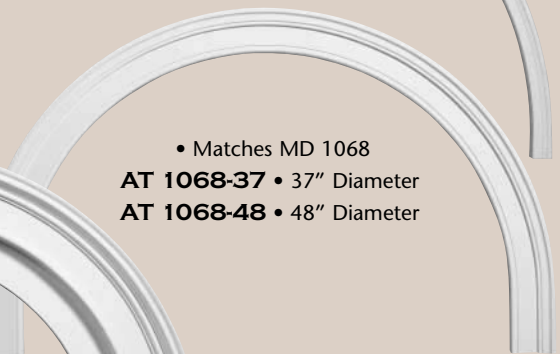

- Matches MD 1068  
**AT 1068-37** • 37" Diameter  
**AT 1068-48** • 48" Diameter





# ENTRANCE & WINDOW SYSTEMS

**NOTICE :**

**PL PREMIUM ADHESIVE MUST BE USED ON ALL JOINTS.**

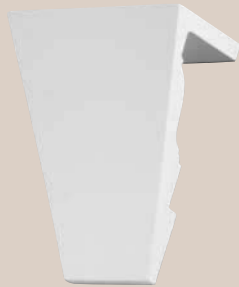

**K 2700**

- 5 1/2" Projection
- 10 1/8" Height
- 8" Width
- For CSH 1015

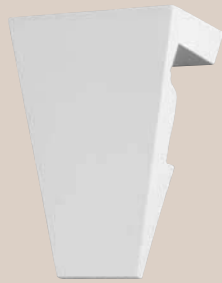

**K 2701**

- 4 1/4" Projection
- 10 1/2" Height
- 8" Width
- For CSH 1035



**K 2702**

- 4 3/4" Projection
- 7" Height
- 8" Width
- For CSH 1052



**K 2703**

- 2 1/2" Projection
- 6 1/2" Height
- 6" Width
- For CSH 1025

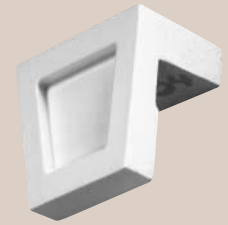

**K 2704**

- 2 3/16" Projection
- 2 7/8" Height
- 3 1/4" Width
- For Brick Mould

## KEYSTONES



**K 2705**

- 2 1/2" Projection
- 7" Height
- 6" Width
- For 5 1/2" Flat Board



**K 2706**

- 4" Projection
- 10" Height
- 6 1/2" Width



**K 2707**

- 3 1/2" Projection
- 7 3/4" Height
- 8 1/4" Width



**K 2708**

- 4 7/8" Projection
- 13 1/2" Height
- 8 3/4" Width
- For CSH 1004



**K 2709**

- 5 1/4" Projection
- 14 1/4" Height
- 10 3/4" Width

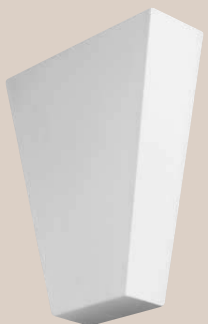

**K 2710**

- 4" Projection
- 13 7/8" Height
- 11 1/2" Width



**K 2711**

- 2 3/4" Projection
- 6 1/2" Height
- 4 1/2" Width
- For MD 1144



**K 2712**

- 3 1/2" Projection
- 6" Height
- 5 7/8" Width



**K 2713**

- 4" Projection
- 12" Height
- 6 1/2" Width
- For BL 2420



**K 2714**

- 4 1/4" Projection
- 7" Height
- 6" Width
- For MD 1267

1 • 8 0 0 • 6 8 5 • 9 9 8 1

